



Cover 3:  
Escape Black

Cover 2:  
Aero Silver

Cover 1:  
Arizona Black

Cover 1:  
Arizona Black

Chrome Feet

# Stella Collection

Colours represented are to be used as a guide only.  
Please refer to manufacturers swatch for a more accurate colour match.

Please note that colour shadings can vary slightly from each roll of fabric.  
We cannot guarantee a precise match to these samples or between cut lengths and upholstered goods.

24/06/2020



# STELLA COVER GUIDE - STANDARD BACK

Please use this guide when ordering the following pieces to clarify cover options.

LH2, R2C (L2, R2C) Group

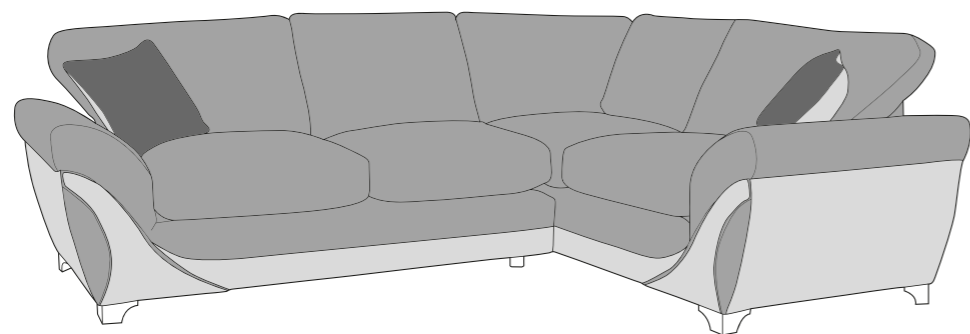

L2C, RH2 (L2C, R2) Group

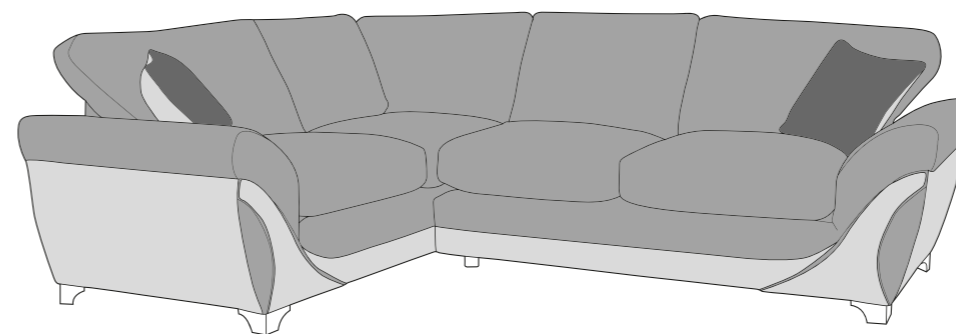

L2C,R2S (L2C, RS2) Group

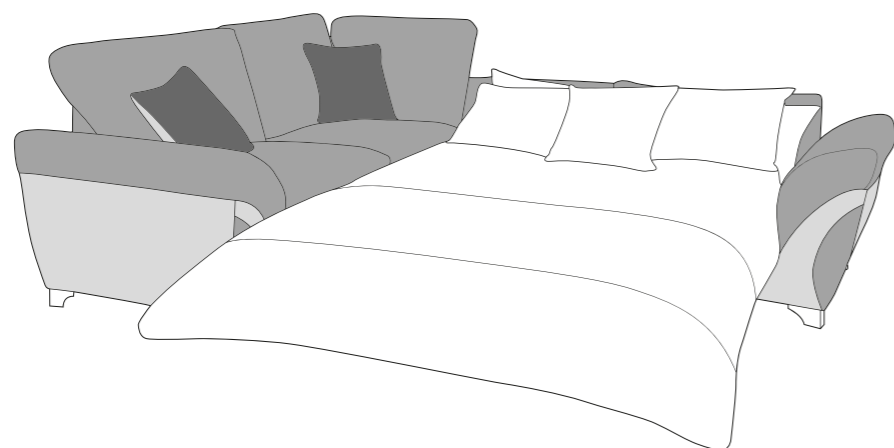

L2S, R2C (L2S, RS2) Group

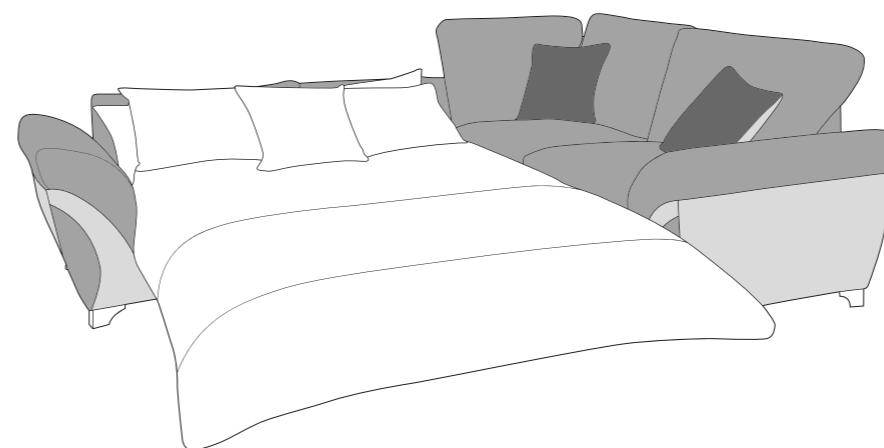

140cm Standard Sofa Bed (3SB)

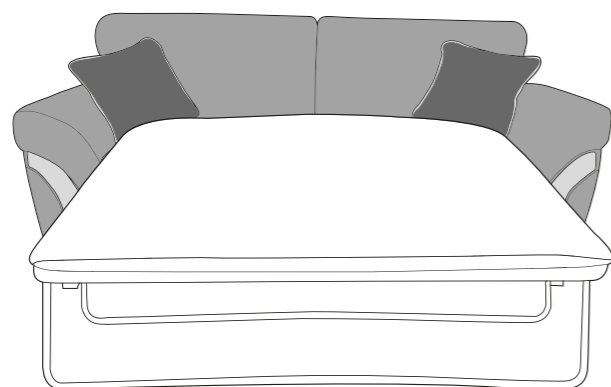

120cm Standard Sofa Bed (2SB)

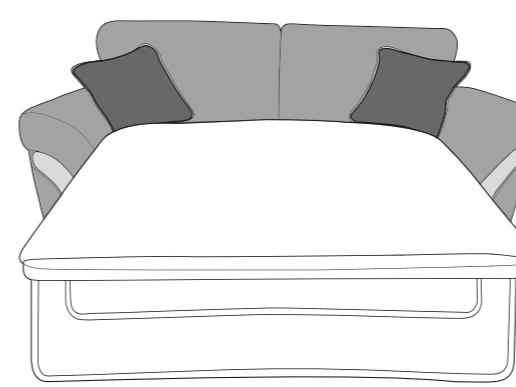

3 Seater sofa (3ST)

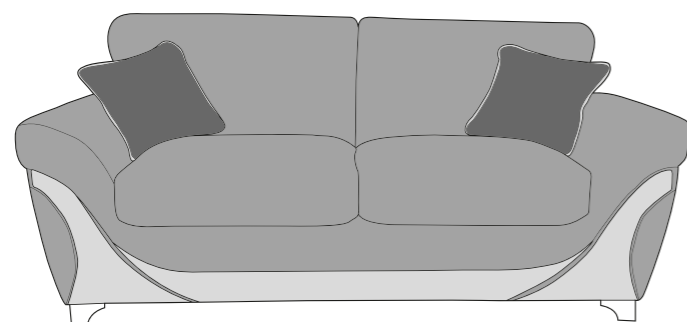

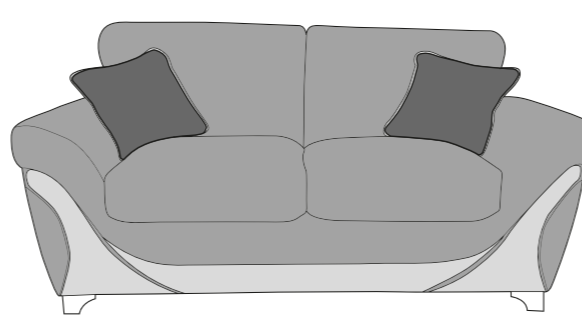

2 Seater sofa (2ST)

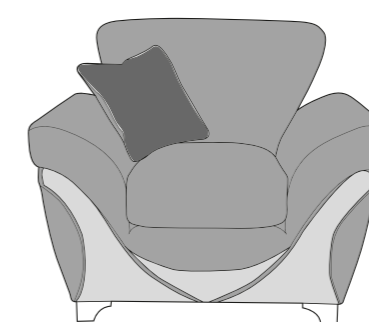

Arm Chair (1ST)



-  **COVER 1**  
(OUTER)
-  **COVER 2**  
(INNER)
-  **COVER 3**  
(SCATTER)

Standard Back Scatter Cushions

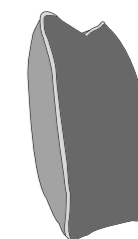

Front = Cover 3  
Piping = Cover 1  
Back = Cover 2

 **British Furniture Manufacturers**  
TRADE ASSOCIATION MEMBER

**A©ID**  
ANTI COPYING IN DESIGN

# STELLA COVER GUIDE - PILLOW BACK

Please use this guide when ordering the following pieces to clarify cover options.

LH2, R2C (L2, R2C) Group

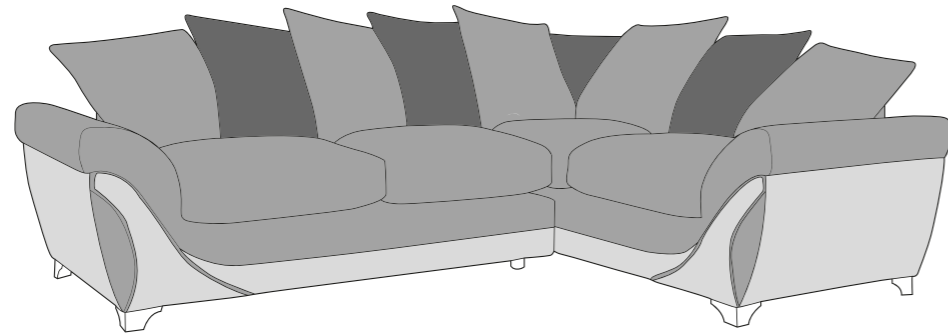

L2C, RH2 (L2C, R2) Group

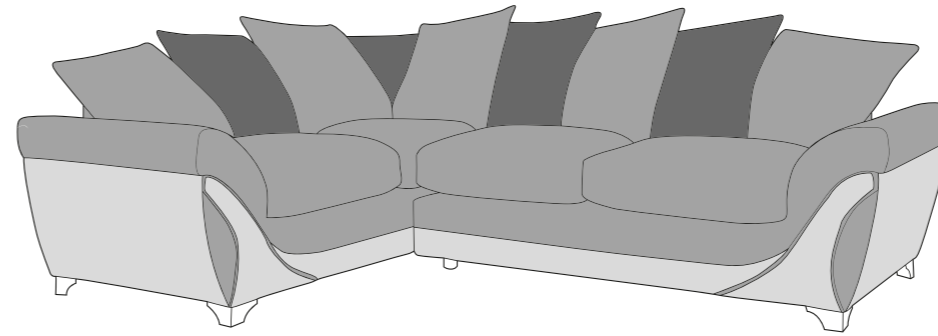

L2C, R2S (L2C, R2S) Group

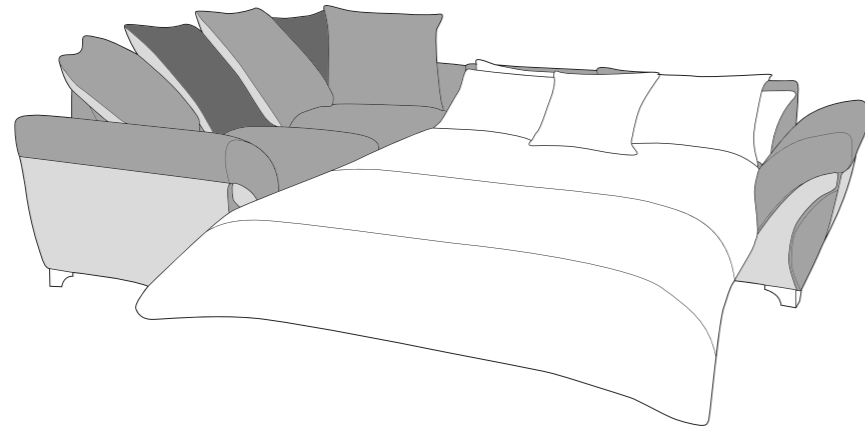

L2S, R2C (L2S, R2S) Group

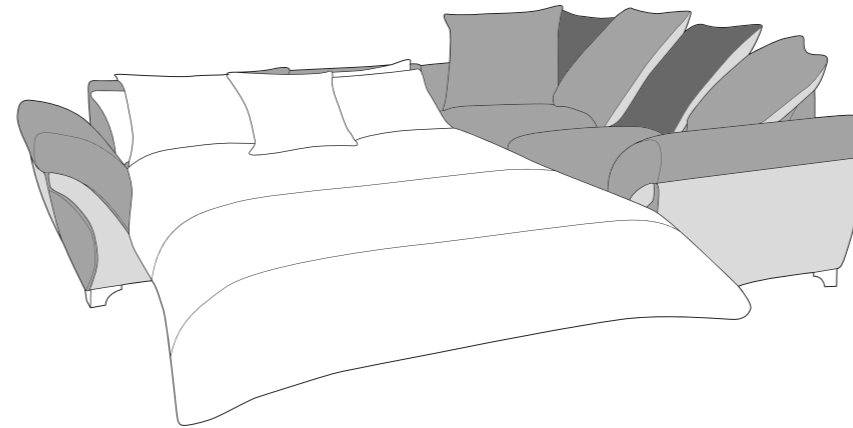

3 Seater sofa (3ST)

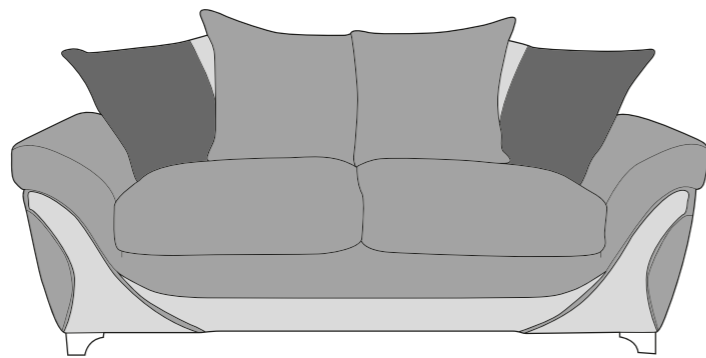

2 Seater sofa (2ST)

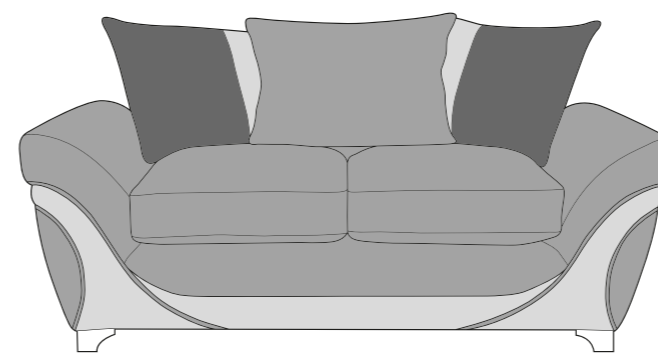

**COVER 1**  
(OUTER)

**COVER 2**  
(INNER)

**COVER 3**  
(PILLOW)

Standard Back Scatter Cushions

Front = Cover 3  
Piping = Cover 1  
Back = Cover 2

## ACCENT PIECES

Storage Footstool (FSS)

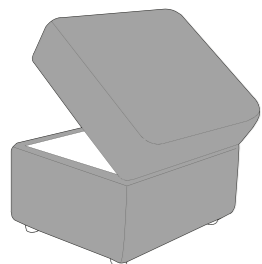

# STELLA DIMENSIONS (CM)

AVAILABLE PIECES	HEIGHT 1	WIDTH 2	DEPTH 3	SEAT HEIGHT 4	SEAT DEPTH (STD) 5	SEAT DEPTH (PILLOW) 5	SEAT WIDTH 6	ACCESS DIAGONAL 7	WEIGHT (KG)	PILLOW BACK NO.	SCATTER CUSHION NO.
LH2, R2C GROUP or L2C, RH2 GROUP	94	284	209	54	61	N/A	N/A	N/A	110	9 (5 PLAIN, 4 MIXED)	2
LH2, R2S GROUP or L2S, RH2 GROUP	94	284	209	54	61	N/A	N/A	N/A	122	9 (5 PLAIN, 4 MIXED)	2
LH2/RH2 UNIT	94	188	96	54	61	62	151	208	50	4 (2 PLAIN, 2 MIXED)	1
L2C/R2C UNIT	94	209	96	54	61	62	160	149	60	5 (3 PLAIN, 2 MIXED)	1
3 SEATER SOFA (3ST)	94	214	96	54	61	62	160	229	56	4 (2 PLAIN, 2 MIXED)	2
2 SEATER SOFA (2ST)	94	193	96	54	61	62	136	214	54	3 (1 PLAIN, 2 MIXED)	2
ARM CHAIR (1ST)	94	115	96	54	61	62	58	145	37.5	N/A	1
<b>SOFA BEDS</b>											
3SB - 140CM STANDARD SOFA BED	94	214	96	54	61	62	160	229	79	4 (2 PLAIN, 2 MIXED)	2
2SB - 120CM STANDARD SOFA BED	94	193	96	54	61	62	136	214	68.5	3 (1 PLAIN, 2 MIXED)	2
L2S/R2S (140CM SOFA BED UNIT) STANDARD	94	188	96	54	61	62	151	208	62	4 (2 PLAIN, 2 MIXED)	2
<b>OPEN DEPTH OF SOFA BEDS 226CM</b>											
<b>ACCENT PIECES</b>											
STORAGE FOOTSTOOL	45	63	50	N/A	N/A	N/A	N/A	75	12.5	N/A	N/A

- \* Hardwood & composite board frame.
- \* Dowelled, screwed, glued & stapled joinery.
- \* Chrome & Wood foot options.

- \* Comfortable and supportive high density foam seat cushions.
- \* Reversible Fibre filled backs for added comfort.
- \* Available in standard back and pillow back option.

- \* Serpentine seat springs & silent wire.
- \* Elasticated back webbing.

## SOFABEDS: 2 SLEEP OPTIONS

**STANDARD ACTION & FOAM MATTRESS**  
A three fold metal action with a sprung 'polyprop' base. Complemented by a high performance foam mattress. For occasional use only.

**Mattress Thickness: 6cm**  
**Mattress Length: 185cm**  
**3 fold action is 140Kg total max occupancy weight**



140cm sofa bed: 3S (3SB) Mattress Width: 133cm  
120cm sofa bed: 2S (2SB) Mattress Width: 113cm

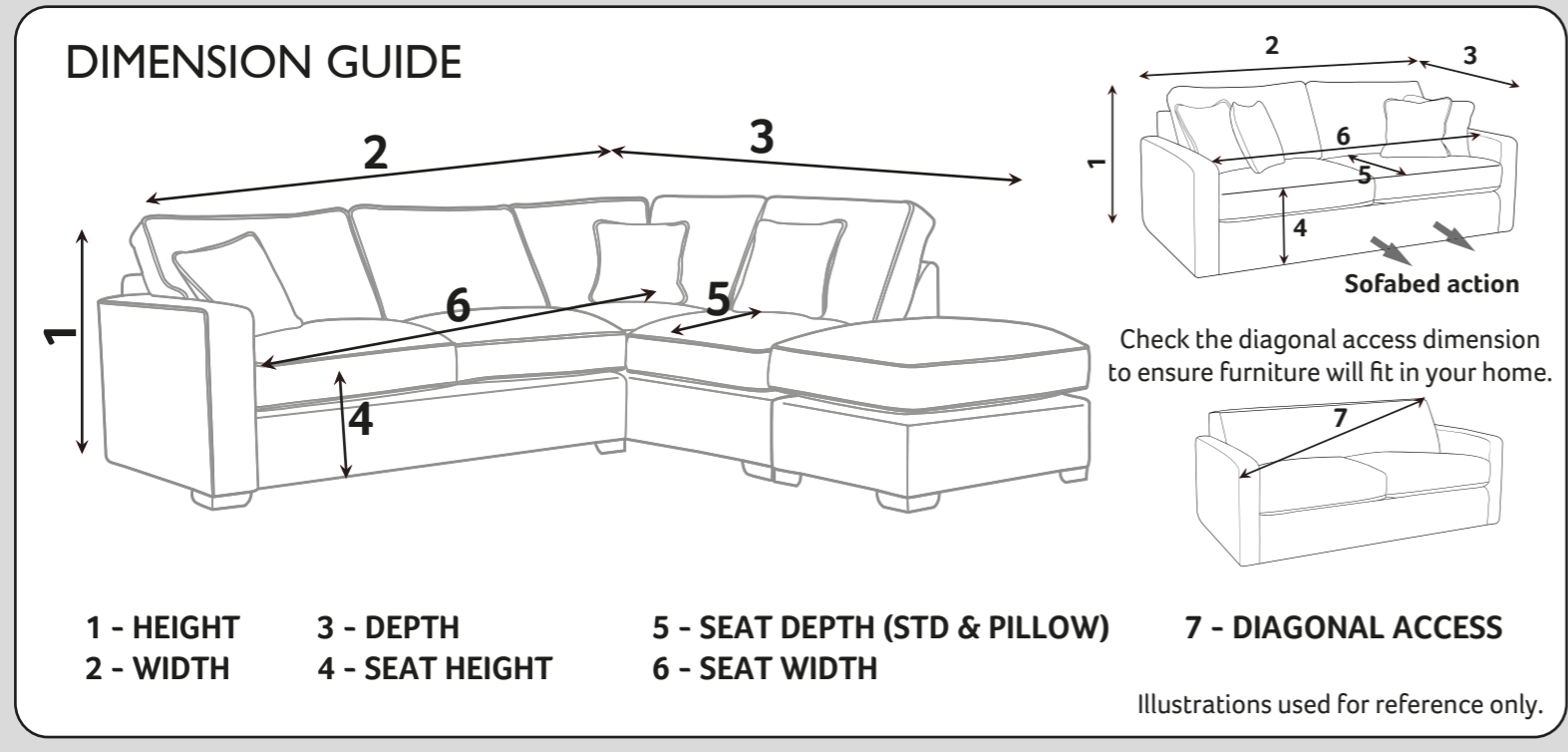

## HIGH DENSITY FOAM SEATS

Our high density foam seat interiors offer a comfortable and supportive sit whilst maintaining their shape.

## CARE GUIDE

To improve the longevity of your hand-made furniture, we recommend rotating cushions (where applicable).

For further information on maintaining your furniture, please refer to the Care Guide located under the seat platform.

**FOOT OPTIONS:**

Chrome    Beech (Light)    Antique (Dark)



Wood is a natural product and will vary in shade/colour from item to item. Feet may require fitting.

Please note : All dimensions are approximate. Allow tolerance of +/- 2.5cm.

